

## ***DISC MOWERS***

 **NK 3300 F**

 **NK 2400**  
**NK 2800 VC**  
**NK 3300 VC**

 **NK 9100**  
**NK 10700 SF**



## **ELHO - MADE IN FINLAND**



**ELHO is a Finnish family-owned business that specialises in the development and manufacture of forage harvesting machinery. The company was founded in 1968 and our products are sold in more than 30 countries around the world, from Europe to Asia. ELHO products are manufactured in Pännäinen, Finland.**

Forage quality is our number one priority. We want to help farmers produce the best possible forage. Our easy-to-use and efficient machines produce clean and pre-dried forage. Our product development, sales and after-sales marketing always work in close cooperation with the farmer.

**ELHO disc mowers** are suitable for both farmers and contractors around the world and for a variety of crops. Particular attention has been paid to the quality and rapid drying of the forage. Rapid drying improves the quality of the forage and allows the crop to be harvested faster.

**ELHO disc mowers** have a simple and durable design. Their light weight means they have a lower power requirement and fuel consumption than mower conditioners. Both disc mowers and mower conditioners use the same, sturdy cutter bar.

**ELHO's product selection offers farmers the most suitable disc mowers** for swathing, spreading or combining.



### NK F – Front disc mowers

ELHO front disc mowers feature the Pendulum Centre System, which allows the mowing unit to move freely in its support frame. PCS enables the disc mower to be pulled and not pushed, thereby avoiding obstacles due to twisting and rocking.



### NK VC – Vertical Centre disc mowers

ELHO Vertical Centre disc mowers follow the centreline of the tractor when raised, so the centre of balance is as close to the centreline as possible and the combination is stable to transport. All VC models feature patented HydroBalance suspension, which allows the tractor to carry most of the machine's weight. The precise suspension mechanism prevents contaminants from being lifted into the forage and saves fuel. In the event of an obstacle, the mechanical release allows the disc mower to move back and forth. The disc mower then automatically returns to the working position immediately after the obstacle.



### Butterfly disc mowers

ELHO butterfly disc mowers are ideal for large farms and contracting. A butterfly disc mower with a front disc mower is a highly productive and balanced combination. The NK 10700 SF model features a SideFlow swath grouper that works with an auger conveyor.

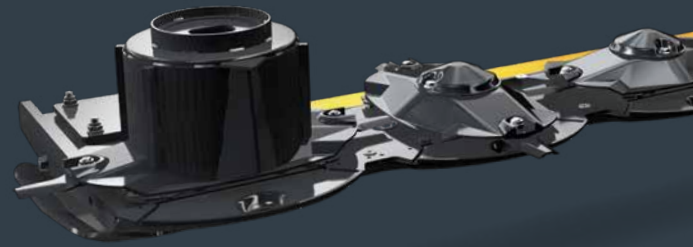

ELHO disc mowers .....	2
Benefits and features of ELHO disc mowers .....	4
Front disc mowers .....	6
NK 3300 F .....	9
Side disc mowers .....	10
NK 2400 .....	12
NK 2800 VC .....	13
NK 3300 VC .....	13
Butterfly disc mowers .....	14
NK 9100 .....	16
NK 10700 SF .....	17
Accessories .....	18
Combinations .....	19
Technical specifications .....	19



## **ROBUST CUTTER BAR**



### **Overload protection**

The protection of the cutter bar is very important for the operation of the disc mower. To keep the gears of the cutter bar in optimal condition at all times, ELHO has developed a protection mechanism for the drive units of the discs. The disc shaft has a fracture groove between the bearings, which disconnects the shaft if it hits a hard object. This ensures that the gears of the cutter bar remain intact. The wide distance between the bearings provides more strength to the drive shaft of the disc.



### **Adjustable hi-skids**

ELHO disc mowers come standard with adjustable hi-skids that makes it easy to increase the mowing height by lowering the hi-skids. The mowing height can be adjusted from 3 cm to 12 cm. The hi-skids are made of Hardox steel. The use of adjustable hi-skids effectively protects both the cutter bar and the ground surface.



**Cutter bar support structure**

A robust support bar extends the life of the cutter bar by reducing impact and bending loads. In the event of a collision, the force of the impact is directed from the high skid to the support bar instead of to the cutter bar.



Cutter bar cleaners

**Mowing discs**

The low profile of the mowing discs ensures a good mowing pattern and prevents impediments from getting under the disc. The oval shape of the discs effectively moves the forage forward. The discs are made of hardened boron steel, and the hardening is done only after welding the cutter bar cleaners. The cutters rotate around their own axis, which extends their life.



**Hi-skids**

The hi-skids cover the entire cutter bar for optimal protection. The hi-skids are made from hardened boron steel and are molded. The weld seam is protected on the inside. The reinforcements in the hi-skids help keep the cutter clean.

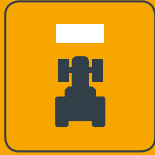

## ***FRONT DISC MOWERS***



**ELHO front disc mowers are pulled** not pushed. They feature an upper support frame to which the actual mowing unit is attached. The mowing unit is free to swing and rotate according to the field surface and possible obstacles. HydroBalance suspension keeps the blade bar at the right weight against the ground at all times. Because the front mower conditioner is controlled by its own hydraulic functions, it can be controlled from the desired location, for example next to the controls for the rear mounted mowers. With the NK 10700 butterfly combination, the front unit can be set to work automatically with the rear unit.

**The NK 3300 F makes swaths that fit between the wheels of the tractor**, preventing damage to the forage. Front disc mowers work well in combination with rear mounted disc mowers. Front mounted disc mowers can also be used with the tractor's reverse-drive system by rotating the mower's bevel gear.

## PENDULUM CENTER SYSTEM

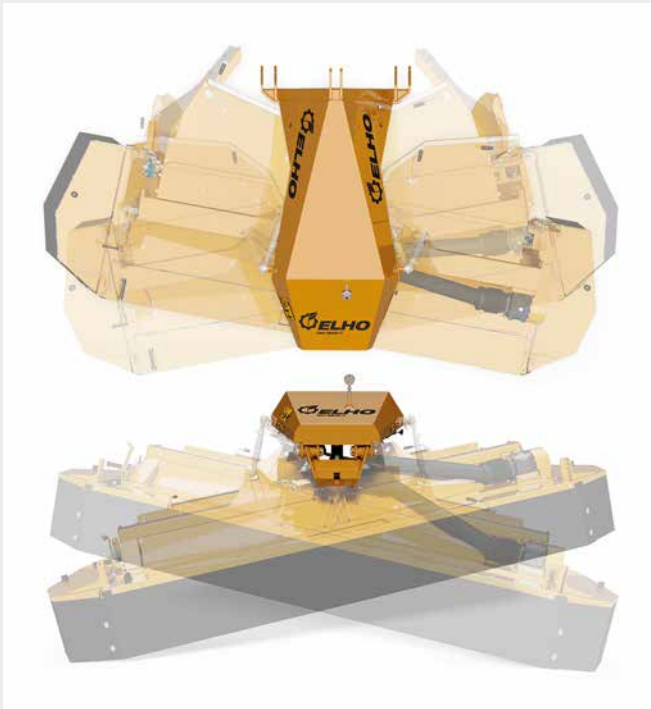

The Pendulum Centre System (PCS) connects the cutter bar to the upper frame. The lightened cutter bar swings and rotates, following the field surface and avoiding obstacles, such as rocks. PCS enables the disc mower to be pulled and not pushed, allowing for lighter operation among plants. The hydraulics of the disc mower lighten and lift the mowing unit on the headland, keeping the tractor's linkage at the standard height.

## HYDROBALANCE SUSPENSION



HydroBalance is a key feature of ELHO disc mowers. Even if the mower weighs tonnes, HydroBalance uses a cylinder and a gas accumulator to lighten most of the weight of the machine to be carried by the tractor. The suspension prevents the cutter bar from lifting contaminants into the forage by lightly following the field surface. The low friction also helps reduce fuel consumption. ELHO has been a pioneer in the field in developing suspension systems.

## HYDROBALANCE TOP LINK



The HydroBalance top link replaces the standard top link, increasing the suspension of the front disc mower and providing more lifting space. As a result, front disc mowers can be lifted tens of centimetres higher, preventing contact with high swaths on the headland, even when using the SideFlow swath grouper. HydroBalance is ideal for tractors with front axle suspension, which require more room for movement for front mounted units. The HydroBalance top link works together with HydroBalance suspension. The HydroBalance top link is available as an option on all front disc mowers.



CAN BE USED IN COMBINATION WITH THE FOLLOWING REAR MOUNTED DISC MOWERS



**NK 2800 VC**

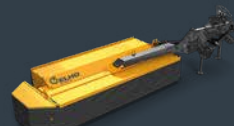

**NK 3300 VC**



**NK 9100**

# NK 3300 F

A front disc mower with suspension that produces clean forage.



Watch video



Read more

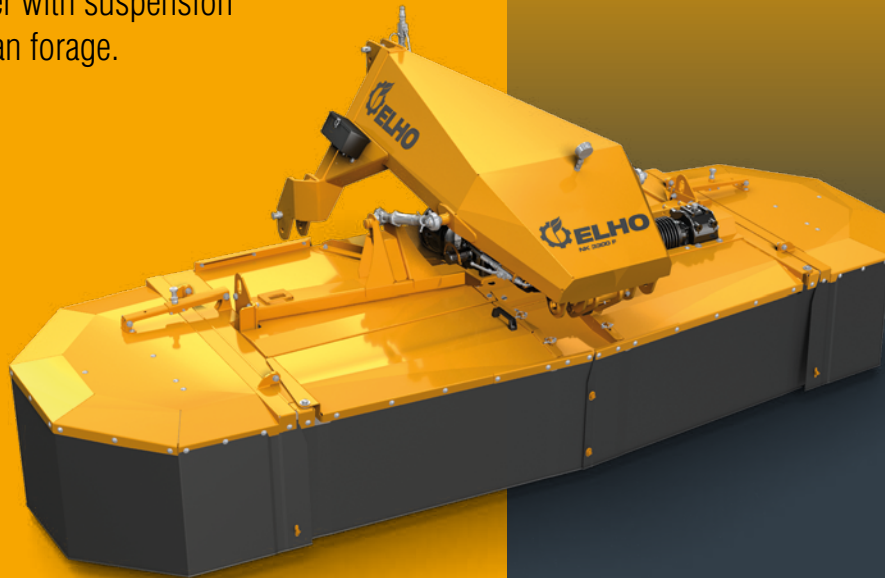

The NK 3300 Front features the Pendulum Center System (PCS), which enables the disc mower to move backwards, swing and rotate. On headlands, the disc mower follows the driving line. If the cutting unit hits an obstacle, the suspension reduces the force of the impact by 50 percent.

The NK 3300 F closely follows the field surface thanks to PCS and Hydro-Balance suspension. This light and precise disc mower produces exceptionally clean forage. The NK 3300 F is a good combination with Vertical Centre disc mowers and especially butterfly disc mowers

### ELHO NK 3300 F

- PCS suspends the disc mower from the centre of the upper frame above and in front of the conditioner
- HydroBalance enables the disc mower to follow closely the field surface
- PCS reduces the force of impacts by up to 50 percent
- Can also be operated in reverse on tractors with a reverse-drive system



#### STANDARD EQUIPMENT

- Primary shaft with overrunning clutch for front PTO or reverse-drive PTO
- Bevel gear 1000 rpm
- Adjustable hi-skids
- HydroBalance suspension



#### OPTIONAL EQUIPMENT

- |                                |        |                                  |        |
|--------------------------------|--------|----------------------------------|--------|
| • Standard knife kit           | 115158 | • HydroBalance top link Cat2/3   | 115391 |
| • Flat knife kit               | 115168 | • LH Link pivoting front linkage | 152083 |
| • Hydraulic kit for sideguards | 115520 |                                  |        |
| • Side lights kit              | 115355 |                                  |        |







## ***SIDE DISC MOWERS***



**ELHO offers a comprehensive range of side disc mowers**, from a 2.4-metre wide model to a 3.3-metre model. Some models feature HydroBalance suspension, which allows the tractor to carry most of the weight of the disc mower. HydroBalance helps produce clean forage and save fuel. Side disc mowers are suspended in the middle, allowing them to swing freely.

**In transport mode, side disc mowers are raised vertically above the tractor's centreline.** This makes them safe to transport by keeping the combination narrow and maintain the centre of gravity over the centreline.

**Side disc mowers are suitable for all types of forage plants** and can also be combined with front disc mowers.

## RELIABLE SWATHING



ELHO disc mowers are available with optional swathing capabilities. The swaths are made using double endplates for a total of four plates. The plates are high and the technical solution extremely simple and reliable.

## HYDROBALANCE SUSPENSION

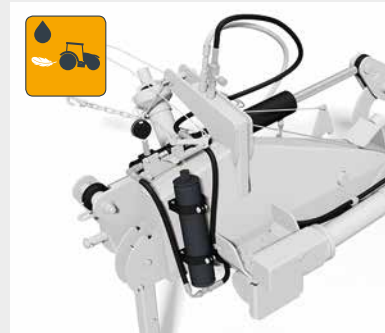

HydroBalance is a key feature of ELHO disc mowers. Even if the mower weighs tonnes, HydroBalance uses a cylinder and a gas accumulator to lighten most of the weight of the machine to be carried by the tractor. The suspension prevents the cutter bar from lifting contaminants into the forage by lightly following the field surface. The low friction

also helps reduce fuel consumption. ELHO has been a pioneer in the field in developing suspension systems.

## OPTIMAL STABILITY DURING TRANSPORT



Side disc mowers are raised above the tractor's centreline during transport, so the centre of balance is as close to the centreline as possible and the combination is stable to transport. When fully raised, side disc mowers are also narrow and do not extend beyond the sides of the tractor.

## MECHANICAL IMPACT PROTECTION



Mechanical impact protection enables the disc mower to move back and up if it hits an obstacle. The disc mower then returns immediately and automatically to its working position.



CAN BE USED IN COMBINATION WITH THE FOLLOWING FRONT DISC MOWERS



**NK 3300 F**

# NK 2400

Impressive flow with high driving speeds,  
also with smaller tractors.



Read more



The ELHO NK 2400 disc mower is known for its impressive flow, high driving speeds and clean forage. The adjustable skid shoes and HydroBalance suspension enable the cutter bar to follow the field surface precisely without hitting the ground.

Side disc mowers are ideal for use also with smaller tractors on the farm. For example, the NK 2400 can be used with a relatively light 40-horsepower tractor. In addition to agricultural tasks, these models are also suitable for maintaining landscapes and mowing roadsides.

Side disc mowers enable forage to be harvested with precision. For example, when working with butterfly units, unmown areas can be left between the disc mower and the front machine when making sharp turns. Using a combination of a front disc mower and a side disc mower, it is possible to turn as sharply as possible without leaving any unmown areas.



## ELHO NK 2400

- Easy to use
- Own lift cylinder enables fast turns on the headland
- Centre of gravity over the tractor's centreline in transport mode



### STANDARD EQUIPMENT

- Primary shaft with overrunning clutch
- Bevel gear 540 rpm
- Mechanical impact protection



### OPTIONAL EQUIPMENT - Availability may vary according to market

- |                                |        |
|--------------------------------|--------|
| • Standard knife kit 2,4 m     | 115156 |
| • Flat knife kit L+R 2,4 m     | 115166 |
| • Swath disc, right side       | 115513 |
| • Swath disc, left side        | 115514 |
| • Outer swath disc, right side | 115513 |



# NK 2800 VC 3300 VC

Vertical Centre disc mowers with impressive features



Watch video, 2800 VC & 3300 VC



Read more



The versatile NK 2800 and 3300 Vertical Centre disc mowers meet a wide range of needs. Standard features include a light kit and counterweight. Vertical Centre disc mowers follow the centreline of the tractor when raised for optimal stability in transport mode. HydroBalance suspension enables the cutter bar to follow the field surface precisely without hitting the ground. In the event of an obstacle, the HydroActive release device allows the disc mower to move back and forth. The disc mower then automatically returns to the working position immediately after the obstacle.

### ELHO NK 2800 VC & 3300 VC

- Own lift cylinder enables fast turns on the headland
- Efficient mowing even with 60-horsepower tractors
- HydroBalance suspension and mechanical impact protection

#### ✓ STANDARD EQUIPMENT

- Primary shaft with overrunning clutch
- Bevel gear 540 rpm (2800 VC)
- Adjustable hi-skids
- HydroBalance suspension
- Mechanical impact protection
- Bevel gear 1000 rpm (3300 VC)

#### + OPTIONAL EQUIPMENT - Availability may vary according to market

##### NK 2800 VC

- Standard knife kit 2,8 m 115158
- Flat knife kit L+R 2,8 m 115168
- Bevel gear 1000 rpm, factory fitted 506127
- Swath narrowing kit 115517
- PTO shaft with shear bolt 152051
- PTO shaft with friction clutch 528606

##### NK 3300 VC

- Standard knife kit 3,2 m 115158
- Bevel gear 540 rpm, factory fitted 506131
- Swath narrowing kit 115522
- PTO shaft with shear bolt 152051
- PTO shaft with friction clutch 528606



## ***BUTTERFLY DISC MOWERS***



**ELHO butterfly disc mowers are efficient combinations for large farms and contracting.** With a combination of a front mounted disc mower and double butterfly disc mower, up to 15 hectares of forage can be harvested per hour. The forage can either be scattered, formed into multiple swaths or grouped into one large swath across the entire working width.

**Butterfly mower conditioners are available for a wide variety of needs.** The 9.1-metre butterfly disc mower is very simple in construction and reliable. The 10.7-metre model in turn is the most advanced disc mower on the market with its numerous automatic functions, SideFlow auger conveyor and GPS assistance.

## HYDROACTIVE IMPACT PROTECTION

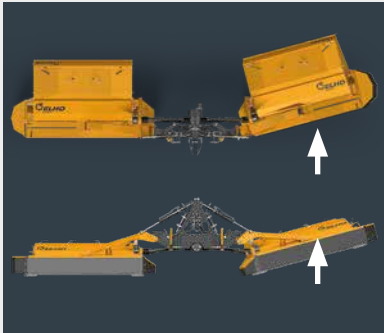

HydroActive impact protection effectively protects the mowing unit in case of obstacles. HydroActive impact protection uses a lift cylinder and release cylinder. When the release cylinder is pressed due to an obstacle, oil from the release cylinder is sent to the lift cylinder. This lifts the mowing unit, which then returns automatically to its working position after the obstacle.

## HYDROBALANCE SUSPENSION

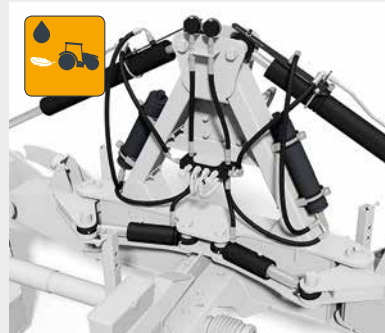

HydroBalance is a key feature of ELHO disc mowers. Even if the mower weighs tonnes, HydroBalance uses a cylinder and a gas accumulator to lighten most of the weight of the machine to be carried by the tractor. The suspension prevents the cutter bar from lifting contaminants into the forage by lightly following the field surface. The low friction

also helps reduce fuel consumption. ELHO has been a pioneer in the field in developing suspension systems.

## COMPACT AND NARROW TO TRANSPORT



All ELHO butterfly disc mowers go quickly and easily into a very narrow transport mode. Even the NK 10700 SF model with the SideFlow auger conveyor is compact and has a centre of gravity close to the tractor.

## EXCELLENT ERGONOMICS



Butterfly disc mowers are operated with the operator looking directly at the machine, preventing stress to the back and neck. When operated in reverse using the tractor's reverse-drive system, the cutting units are in clear view. The NK 10700 SF model features Headland Automatics (HA) and Automatic Curve Compensation (ACC) to further facilitate operation.



CAN BE USED IN COMBINATION WITH THE FOLLOWING  
FRONT DISC MOWERS OR MOWER CONDITIONERS



**NK 3300 F**



**NM 3700 F**

# NK 9100

A butterfly disc mower that does not require a large tractor.



Watch video



Read more

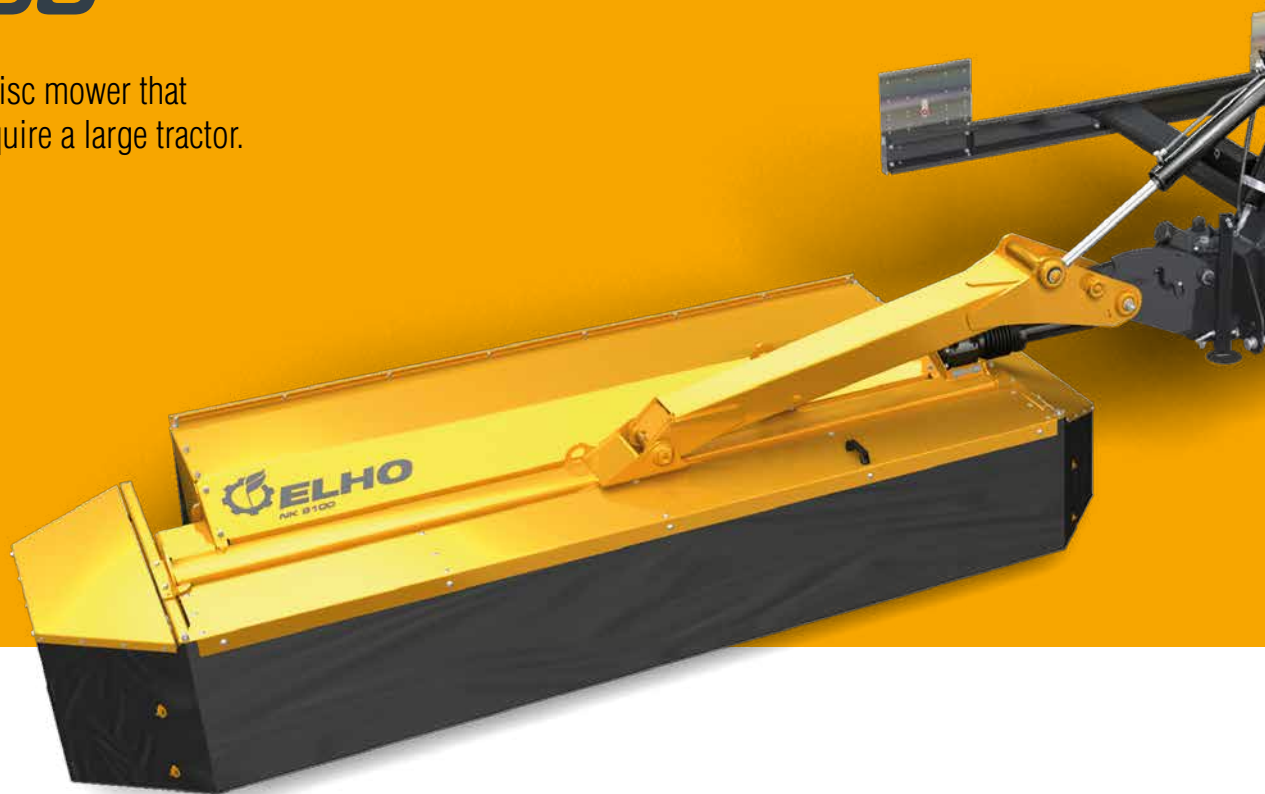

The ELHO NK 9100 is the ideal disc mower for contractors and large farms. This powerful machine offers optimal weight distribution, excellent usability, Hydro-Balance suspension and HydroActive impact protection. In transport mode, the centre of gravity is over the tractor's centreline, so even a smaller tractor remains stable. A butterfly combination with a front mounted disc mower is suitable for tractors with 150 or more horsepower.

#### ELHO NK 9100

- Low weight and even weight distribution
- Low power requirement compared to width, high capacity
- HydroBalance suspension and HydroActive impact protection
- Quick transfer between transport mode and work position







### Swath discs

ELHO disc mowers are available with optional swath discs. Swathing is performed by the two outer discs, so by four discs altogether. The two outer discs rotate inwards, effectively moving the forage into the swath.



#### STANDARD EQUIPMENT

- Primary shaft with overrunning clutch and overload protection
- Bevel gear 1000 rpm
- Adjustable hi-skids
- HydroBalance suspension
- HydroActive impact protection
- Light kit



#### OPTIONAL EQUIPMENT - Availability may vary according to market

- |                                |        |                                |        |
|--------------------------------|--------|--------------------------------|--------|
| • Standard knife kit 9,1 m     | 115161 | • Mountain driving kit         | 115364 |
| • Flat knife kit L+R 9,1 m     | 115171 | • Electronic headland lift kit | 115389 |
| • Hydraulic kit for sideguards | 115363 | • HydroBalance electric kit    | 115385 |
| • Swath narrowing kit          | 115523 |                                |        |

# NK 10700 SF

Widest butterfly disc mower  
on the market.



Read more

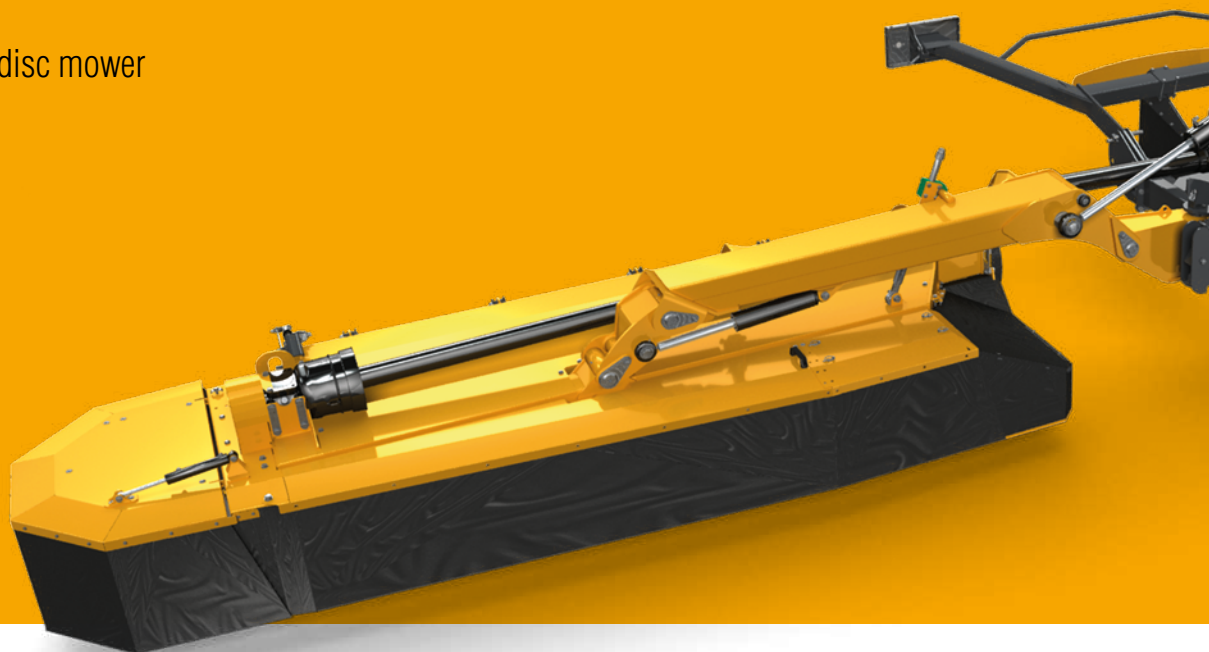

The ELHO NK 10700 butterfly disc mower offers an adjustable working width from 9.6 to 10.7 metres, enabling it to be used together with front mowers of different sizes. Both sides can be adjusted individually, either manually or automatically. AutoBalance, i.e. automatic HydroBalance suspension, maintains the optimal position at all times, also in curves. Automatic Curve Compensation (ACC) uses the machine's own GPS system to adjust the overlap of the cutter bars in curves to prevent any unmown areas between the front and rear units. The same GPS system is used for the Headland Automatics (HA), which raises the rear disc mowers automatically at the exact same spot where the front units were raised. In this way, the operator can focus on the front unit alone. The HydroActive hydraulic release device provides impact protection in case of obstacles, while the SideFlow auger conveyor is ideal for harvesting forage plants with stalks. For the ultimate cutting power and highest possible comfort levels, the NK 10700 is the right choice!

## ELHO NK 10700 SF

- 10.7-metre cutting width with a 1.1-metre width adjustment range
- AutoBalance automatic suspension system and HydroActive impact protection
- Automatic Curve Compensation (ACC) using GPS
- Headland Automatics (HA) using GPS
- Temperature sensors in bevel gears to detect faults
- Centre of gravity close to the tractor provides stable transport
- SideFlow auger conveyor produces clean and level swaths with losses



### STANDARD EQUIPMENT

- Primary shaft 1 3/4" Z=20
- Bevel gear 1000 rpm
- Adjustable hi-skids
- HydroBalance suspension
- HydroActive impact protection
- Electronic control with screen
- Light kit



### OPTIONAL EQUIPMENT - Availability may vary according to market

- Standard knife kit 115160
- Flat knife kit 115170
- USB Navpad 148887

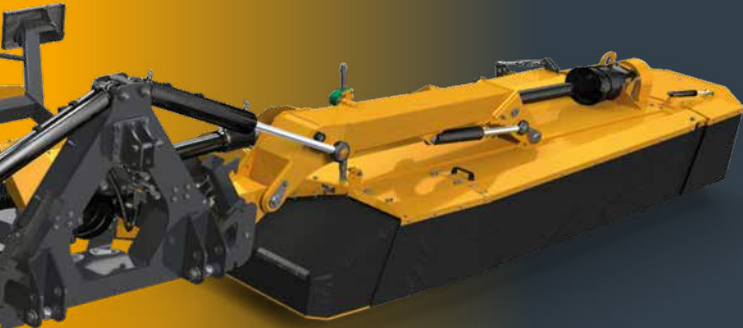

### SIDEFLOW AUGER CONVEYOR

The ELHO NK 10700 SF features the SideFlow auger conveyor. SideFlow is a screw-shaped swath grouper that is extremely reliable: it is equally effective with dry or wet, long or short forage. The SideFlow auger conveyor has a closed structure, so that no forage is wasted, for example when mowing whole grain. SideFlow is lightweight and mounted close to the cutter bar, so the centre of gravity of the machine is close to the tractor. SideFlow is reliable and easy to maintain. It is particularly suitable for harvesting whole grain silage.

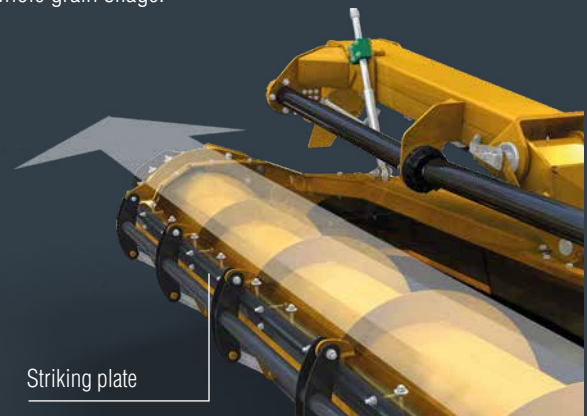

### HEADLAND AUTOMATICS (HA)

Headland Automatics makes work much easier for the driver, who simply has to press a button to raise or lower the front unit in the headland. GPS automatics ensure that the rear units are raised and lowered automatically at the exact same as the front units.



1 2



Entering the headland



1 2



Departing the headland

### GPS TECHNOLOGY

The NM 10700 uses GPS technology for its Headland Automatics (HA) and Automatic Curve Compensation (ACC), as well as for calculating the number of hectares covered.



### SideFlow auger when rear hatches are closed

The auger has a diameter of 45 cm and collects forage effectively from the cutter bar. The forage enters the auger from below and is guided to the space behind the auger. The auger rotates at 500 rpm and creates a level swath. The striking plate behind the auger prevents the hay from spinning around the auger.





### Opening rear hatches

SideFlow models feature rear hatches that open, providing a range of mowing options. For spreading forage, the hatches can be opened on both sides. It is also possible to spread forage on only one side, for example when mowing along the edges of fields. This moves the forage away from the edges, making the next tasks easier.





## **ELHO DISC MOWERS - ACCESSORIES**

### Knife kits for ELHO disc mowers

<b>Standard knife kits</b>		
	<b>NK 2400</b>	115156
	<b>NK 2800 VC</b>	115157
	<b>NK 3300 VC</b>	115158
	<b>NK 3300 F</b>	115158
	<b>NK 9100</b>	115161
<b>Flat knife kits</b>		
	<b>NK 2400</b>	115166
	<b>NK 2800 VC</b>	115167
	<b>NK 3300 VC</b>	115168
	<b>NK 3300 F</b>	115168
	<b>NK 9100</b>	115171
	<b>NK 10700 SF</b>	115170

## Other accessories for ELHO disc mowers

Hydraulic kit for sideguards		
	<b>NK 3300 F</b>	115520
	<b>NK 9100</b>	115363

Mountain driving kit		
	<b>NK 9100</b>	115364

Swath narrowing kit		
	<b>NK 2800 VC</b>	115517
	<b>NK 3300 VC</b>	115522
	<b>NK 9100</b>	115523

Swath discs		
	<b>NK 2400</b>	oikea 115513
	<b>NK 2400</b>	vasen 115514

HydroBalance top link Cat2/3		
	<b>NK 3300 F</b>	115391

HydroBalance electric kit		
	<b>NK 9100</b>	115385

Electronic headland lift kit		
	<b>NK 9100</b>	115389



Side lights kit		
	<b>NK 3300 F</b>	115355

USB Navpad		
	<b>NK 10700 SF</b>	148887

Bevel gear (factory fitted)		
	<b>NK 2800 VC</b>	1000
	<b>NK 3300 VC</b>	540







LH Link pivoting front linkage		
	<b>NK 3300 F</b>	152083

# TECHNICAL SPECIFICATIONS

	 NK 3300 F	 NK 2400	 NK 2800 VC	 NK 3300 VC
<b>Tractor power requirement, min/max, kW*</b>	60-90	40-70	50-80	60-90
<b>Minimum recommended tractor weight, kg*</b>	4500		3500	4000
<b>Working width, m</b>	3,3	2,4	2,8	3,3
<b>Number of discs</b>	8	6	7	8
<b>Adjustable hi-skids</b>	X	0	X	X
<b>HydroBalance suspension</b>	X		X	X
<b>Mechanical suspension</b>		X		
<b>HydroActive release</b>	X			
<b>Mechanical release, automatic return</b>		X	X	X
<b>Transport width, m</b>	3,15	1,2	2,2	2,2
<b>Height in transport mode, m</b>		2,7	3,2	3,6
<b>Weight, kg</b>	800	525	900	980
<b>PTO speed, 540 RPM</b>		X	0	0
<b>PTO speed, 750 RPM</b>	0			
<b>PTO speed, 1000 RPM</b>	X		X	X
<b>Hydraulic coupling, single action</b>	1	1	1	1
<b>Hydraulic pressure, min/max bar</b>	140-210		120-210	120-210
<b>PTO connection 1 3/8"-Z6</b>	X	X	X	
<b>3 point linkage</b>	Cat.2/3N	Cat.2	Cat.2	Cat.2



## ELHO DISC MOWERS - COMBINATIONS

 NK 3300 F	NK 2800 VC 	Working width Overlap 35-45 cm
	NK 3300 VC 	Working width Overlap 35-40 cm
	NK 9100 	Working width Overlap 35-40 cm
 NM 3700 F	NK 10700 SF 	Working width Overlap 20-75 cm



NK 9100



NK 10700 SF

<b>Tractor power requirement, min/max, kW*</b>	110-150 (***)	160-220 (***)
<b>Minimum recommended tractor weight, kg*</b>		
<b>Minimum recommended front mower, m</b>	3,2	3,7
<b>Working width, m</b>	9,1	9,6-10,7
<b>Number of discs</b>	16	18
<b>Adjustable hi-skids</b>	X	X
<b>HydroBalance suspension</b>	X	X
<b>Mechanical suspension</b>	-	-
<b>HydroActive release</b>	X	X
<b>Mechanical release, automatic return</b>		
<b>Transport width, m</b>	3,2	3
<b>Height in transport mode, m</b>	3,8	4,1
<b>Weight, kg</b>	2000(**)	3450(**)
<b>PTO speed, 540 RPM</b>		
<b>PTO speed, 750 RPM</b>		
<b>PTO speed, 1000 RPM</b>	X	X
<b>Load sensing hydraulics</b>	-	X
<b>Hydraulic coupling, single action</b>	2	
<b>Hydraulic coupling, double action</b>		2
<b>Hydraulic pressure, min/max bar</b>	150-210	180-210
<b>PTO connection 1 3/8"-Z6</b>	X	
<b>PTO connection 1 3/4"-Z20</b>		X
<b>3 point linkage</b>	Cat.2/3	Cat.3

\*) The tractor weight and power is determined based on the conditions

\*\*\*) front mower not included

\*\*) front mower Included

X = Standard 0 = Option - = Not available

Your Elho dealer

Manufacturer

**OY EL-HO AB**

Teollisuustie 6

F-68910 Pännäinen, Finland

Tel. +358 6 7888 000

ELHO@ELHO.fi

www.ELHO.fi